

## T032NSL940DAPW | RAY 115

### Professional adjustable LED projector

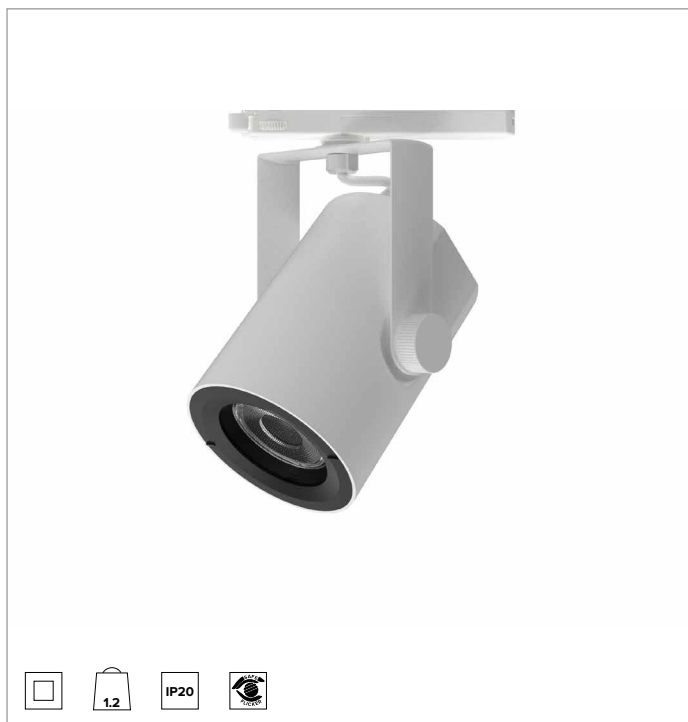

	4000K	H(m)	D(m)	Emax(lx)		
	Ra90		9°			
	Fixture Power	22W	1	0.17	50552	
	Source Flux	2087lm	2	0.33	12638	
	Fixture Flux	1714lm	3	0.50	5617	
	Efficacy	77lm/W	4	0.66	3160	
TS1909	Imax=24222cd/klm	Imax	50552cd	5	0.83	2022

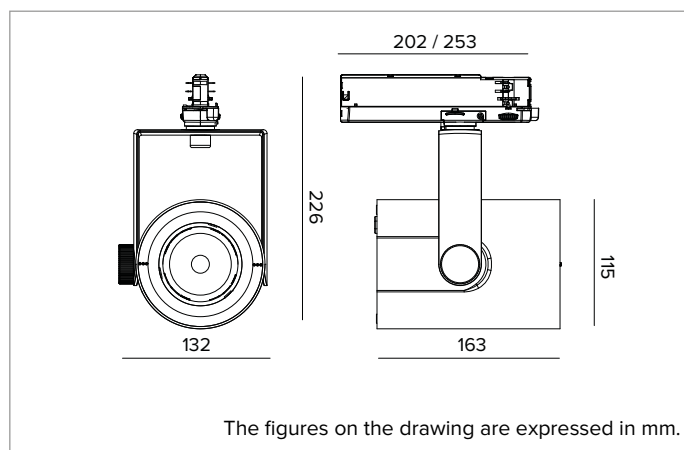

#### SOURCE

High efficiency Chip on Board LED Ra90. Ra97 on request.

**Energy efficiency class:** F

**Nominal power:** 19W

**Nominal flux:** 2087lm

**Colour rendering index:** 90

**Rf:** 90

**Rg:** 98

**CCT nominal:** 4000K

**Lifetime (L80/B10):** >50000h tq +25°C

#### ILLUMINOTECHNICAL CHARACTERISTICS

Optical grade PMMA TIR lens. Interchangeable lenses available as accessories (excluding the Narrow Spot optic).

**Optic:** LENS

**Beam angles:** NSP

**Optical efficiency:** 82%

**Fixture flux:** 1714lm

**Luminous efficacy:** 77lm/W

**Photobiological safety:** Compliant with RG1 low risk group

#### MECHANICAL CHARACTERISTICS

Painted die-cast aluminium body. Black painted polycarbonate front ring. Adjustable from 0° to -90° on the vertical plane and 359° on the horizontal plane. Mechanical beam locking system on the vertical plane and friction beam locking system on the horizontal plane. The centre of gravity always remains in axis with the track regardless of the aiming.

**Colour and finish:** Plaster white

**Dimensions:** 115

**Weight:** 1.2Kg

**Degree of protection:** IP20

#### ELECTRICAL CHARACTERISTICS

DALI electronic driver integrated into the track adapter.

**Fixture Power:** 22W

**Power supply:** 220-240Vac 50/60Hz

**Insulation Class:** CLASS 2

**Type of driver / Control:** DALI

**Driver included:** YES

**Class F:** YES

**SAFE FLICKER:** PstLM=<1 and SVM=<0.4 (IEC TR 61547-1 and IEC TR 63158), to ensure a more comfortable and safe light

**Ambient temperature:** 0°C / +25°C

#### INSTALLATION

Electrified track mounting. Optical accessories that can be installed with a support ring are available.

#### WARRANTY

5 years.

#### WARNING

Luminaire designed for disposal/recycling at end-of-life. Replaceable (LED only) light source by a professional. Replaceable control gear by a professional.

*Due to the technological evolution of the electronic components, the data provided may be updated, and as such, confirmation must be requested during the order process.*

*Luminous flux and power supply have +/-10% tolerances with respect to the indicated value. tq +25°C (CIE 121).*

*We reserve the right to make technical changes.*

Targetti Sankey S.r.l.  
Via Pratese, 164  
50145 Firenze - Italy  
Tel: +39 055 37911  
targetti.com  
targetti@targetti.com

CCIAA Firenze  
Share Capital:  
€ 500.000,00  
VAT N. (IT):  
01537660480  
R.E.A.: FI-275656

**TARGETTI**

**T032NSL940DAPW | RAY 115**  
Professional adjustable LED projector

**Accessories**

**Screen**



Colour	Code
●	<b>A079</b>

Black polycarbonate accessory holder ring.



Ø mm	Code
80	<b>1T3143</b>

Black painted anodized diffusive aluminium asymmetric screen.  
Complete with blade light filter.  
Ideal for a Wall Washer effect.  
To be combined with spot and flood optics.  
For RAY 115 versions with lens.

**Grid**



Ø mm	Code
70	<b>1T1711</b>

Anti-glare louver.  
Black painted metal honeycomb structure.  
To be completed with a dedicated holder ring A079.  
For RAY 115 versions with lens.

**Filter**



Ø mm	Code
70	<b>1T1708</b>

Flat striped glass blade light refractive filter.  
This makes the beam take on an oval shape and when combined with spotlights, the light blade appears more prominent.  
To be completed with a dedicated holder ring A079.  
For RAY 115 versions with lens.

**Cut-off**



Ø mm	Code
80	<b>1T3142</b>

Cut-off Tube.  
Allows for the beam to be focused while removing the fall-off component.

**Ray Shade**



Ø mm	Code
118	<b>A025</b>

Adjustable barn doors flaps made of black painted steel.

Due to the technological evolution of the electronic components, the data provided may be updated, and as such, confirmation must be requested during the order process.  
Luminous flux and power supply have +/-10% tolerances with respect to the indicated value. tq +25°C (CIE 121).

We reserve the right to make technical changes.

Targetti Sankey S.r.l.  
Via Pratese, 164  
50145 Firenze - Italy  
Tel: +39 055 37911  
targetti.com  
targetti@targetti.com

CCIAA Firenze  
Share Capital:  
€ 500.000,00  
VAT N. (IT):  
01537660480  
R.E.A: FI-275656

